



Austrian Institute of Construction Engineering
 Schenkenstrasse 4 | T+43 1 533 65 50
 1010 Vienna | Austria | F+43 1 533 64 23
 www.oib.or.at | mail@oib.or.at



European Technical Assessment

ETA-14/0349
 of 15.12.2022

General part

Technical Assessment Body issuing the European Technical Assessment

Österreichisches Institut für Bautechnik (OIB)
 Austrian Institute of Construction Engineering

Trade name of the construction product

CLT – Cross Laminated Timber

Product family to which the construction product belongs

Solid wood slab elements to be used as structural elements in buildings

Manufacturer

Stora Enso Oyj
 P.O. Box 309
 00101 Helsinki
 Finland

Manufacturing plants

See Annex 1

This European Technical Assessment contains

36 pages including 6 Annexes which form an integral part of this assessment.

This European Technical Assessment is issued in accordance with Regulation (EU) No 305/2011, on the basis of

European Assessment Document (EAD) 130005-00-0304 “Solid wood slab element to be used as a structural element in buildings”.

This European Technical Assessment replaces

European Technical Assessment ETA-14/0349 of 06.04.2020.

Remarks

Translations of this European Technical Assessment in other languages shall fully correspond to the original issued document and should be identified as such.

Communication of this European Technical Assessment, including transmission by electronic means, shall be in full. However, partial reproduction may be made with the written consent of Österreichisches Institut für Bautechnik. Any partial reproduction has to be identified as such.

Specific parts

1 Technical description of the product

1.1 General

This European Technical Assessment (ETA) ¹ applies to the cross laminated timber “CLT – Cross Laminated Timber”. CLT – Cross Laminated Timber is made of softwood boards which are bonded together in order to form cross laminated timber (solid wood slab elements). Generally, adjacent layers of the softwood boards are arranged perpendicular (angle of 90°) to each other, see Annex 2, Figure 1.

The principle structure of the cross laminated timber is shown in Annex 2, Figure 2 and Figure 3. Surfaces of the cross laminated timber are planed or sanded. Surfaces of the boards are planed.

The solid wood slab elements consist of at least three and up to twenty adjacent layers which are arranged perpendicular to each other. With regard to the thickness of the solid wood slab element, thickness and orientation of individual layers are symmetrically assembled. In case of serious deviations from symmetry potential effects should be investigated.

The individual boards of the layers may be side-glued.

A maximum of three adjacent layers may be arranged in the same direction as long as a symmetric cross-section with cross-layering remains and their all over thickness does not exceed 90 mm. When the cover layer is substituted by two adjacent layers oriented in direction of the mechanical action with approximately the same overall thickness a symmetric assembly may be considered.

Single board layers (maximum 50 % of the cross section) may be replaced by one- and multilayer solid wood panels. The solid wood panels shall be suitable for structural use.

The transverse layers may be substituted lamellae type “REX”. Lamellae type “REX” may be side-glued.

The surfaces of the solid wood slabs may be covered with additional layers. This panels are not part of this European Technical Assessment. Strength and stiffness characteristics for mechanical actions perpendicular to and in plane of the cross laminated timber are only assigned to the cross laminated timber without covering.

CLT – Cross Laminated Timber and the boards for its manufacturing correspond to the specifications given in the Annexes 2 and 3. The material characteristics, dimensions and tolerances of CLT – Cross Laminated Timber, not indicated in these Annexes, are given in the technical file² of the European Technical Assessment.

The application of wood preservatives and flame retardants is not subject of the European Technical Assessment.

¹ In 2014 ETA-14/0349 was firstly issued as European Technical Assessment ETA-14/0349 of 02.10.2014, amended to ETA-14/0349 of 19.10.2018, amended to ETA-14/0349 of 07.01.2019, amended to ETA-14/0349 of 03.06.2019, amended to ETA-14/0349 of 06.04.2020 and amended to ETA-14/0349 of 15.12.2022.

² The technical file of the European Technical Assessment is deposited at Österreichisches Institut für Bautechnik and, in so far as is relevant to the tasks of the notified product certification body involved in the assessment and verification of constancy of performance procedure, is handed over to the notified product certification body.

1.2 Components

1.2.1 Boards

The specification of the boards is given in Annex 3, Table 2. Boards are visually or machine strength graded. Only technically dried wood shall be used.

Wood species is European spruce or equivalent softwood.

1.2.2 Lamellae type “REX”

The specification of the lamellae type “REX” is given in Annex 2, Table 2. Lamellae type “REX” are extracted from symmetrical cross laminated timber of European spruce, fir or pine of boards with min. strength class $\geq 90\%$ T14 and $\leq 10\%$ T11 according to EN 338. Lamellae type “REX” show a predefined percentage of end grain on the face of the lamellae, see Figure 4. Only technically dried wood shall be used.

1.2.3 Wood-based panels

The specification of the wood-based panels is given in Annex 3, Table 2. Wood-based panels are in accordance with EN 13986 or a European Technical Assessment.

1.2.4 Adhesive

The adhesive for bonding of the cross laminated timber and the finger joints of the individual boards shall conform to EN 301 or EN 15425.

2 Specification of the intended use(s) in accordance with the applicable European Assessment Document (thereafter EAD)

2.1 Intended use

The solid wood slab is intended to be used as a structural or non-structural element in buildings and timber structures.

The solid wood slab shall be subjected to static and quasi-static actions only.

The solid wood slab is intended to be used in service classes 1 and 2 according to EN 1995-1-1³. Members which are directly exposed to the weather shall be provided with an effective protection for the solid wood slab element in service.

2.2 General assumptions

The solid wood slab elements are manufactured in accordance with the provisions of the European Technical Assessment using the manufacturing process as identified in the inspection of the manufacturing plant by Österreichisches Institut für Bautechnik and laid down in the technical file.

The manufacturer shall ensure that the requirements in accordance with the Clauses 1, 2 and 3 as well as with the Annexes of the European Technical Assessment are made known to those who are concerned with design and execution of the works.

Layers of planed boards shall be bonded together to the required thickness of the cross laminated timber. The individual boards shall be jointed in longitudinal direction by means of finger joints according to EN 14080, there shall be no butt joints.

Adhesive shall be applied on one face of each board. The edges of the boards need not to be bonded.

³ Reference documents are listed in Annex 6.

Design

The European Technical Assessment only applies to the manufacture and use of cross laminated timber. Verification of stability of the works including application of loads on the cross laminated timber is not subject to the European Technical Assessment.

The following conditions shall be observed:

- Design of cross laminated timber members is carried out under the responsibility of an engineer experienced in such products.
- Design of the works shall account for the protection of the cross laminated timber.
- The cross laminated timber members are installed correctly.

Design of cross laminated timber members elements may be according to EN 1995-1-1 and EN 1995-1-2, taking into account of Annex 3 of the European Technical Assessment.

Standards and regulations in force at the place of use shall be considered.

Packaging, transport, storage, maintenance, replacement and repair

Concerning product packaging, transport, storage, maintenance, replacement and repair it is the responsibility of the manufacturer to undertake the appropriate measures and to advise his clients on the transport, storage, maintenance, replacement and repair of the product as he considers necessary.

Installation

It is assumed that the product will be installed according to the manufacturer's instructions or (in absence of such instructions) according to the usual practice of the building professionals.

2.3 Assumed working life

The provisions made in the European Technical Assessment (ETA) are based on an assumed intended working life of CLT – Cross Laminated Timber of 50 years, when installed in the works, provided that the cross laminated timber elements are subject to appropriate installation, use and maintenance (see Clause 2.2). These provisions are based upon the current state of the art and the available knowledge and experience⁴.

The indications given as to the working life of the construction product cannot be interpreted as a guarantee neither given by the product manufacturer or his representative nor by EOTA nor by the Technical Assessment Body, but are regarded only as a means for choosing the appropriate products in relation to the expected economically reasonable working life of the works.

⁴ The real working life of a product incorporated in a specific works depends on the environmental conditions to which that works is subject, as well as on the particular conditions of the design, execution, use and maintenance of that works. Therefore, it cannot be excluded that in certain cases the real working life of the product can also be shorter than the assumed working life.

3 Performance of the product and reference to the methods used for its assessment

3.1 Essential characteristics of the product

Table 1: Essential characteristics of the product and assessment methods

No	Essential characteristic	Product performance
Basic requirement for construction works 1: Mechanical resistance and stability ¹⁾		
1	Bending ²⁾	Annex 3
2	Tension and compression ²⁾	Annex 3
3	Shear ²⁾	Annex 3
4	Embedment strength	Annex 3
5	Creep and duration of the load	Annex 3
6	Dimensional stability	Annex 3
7	In-service environment	Annex 3
8	Bond integrity	Annex 3
Basic requirement for construction works 2: Safety in case of fire		
9	Reaction to fire	Annex 3
10	Resistance to fire	Annex 3
Basic requirement for construction works 3: Hygiene, health and the environment		
11	Content, emission and/or release of dangerous substances	3.1.1
12	Water vapour permeability – Water vapour transmission	Annex 3
Basic requirement for construction works 4: Safety and accessibility in use		
13	Impact resistance	Annex 3
Basic requirement for construction works 5: Protection against noise		
14	Airborne sound insulation	Annex 3
15	Impact sound insulation	Annex 3
16	Sound absorption	Annex 3
Basic requirement for construction works 6: Energy economy and heat retention		
17	Thermal conductivity	Annex 3
18	Air permeability	Annex 3
19	Thermal inertia	Annex 3
¹⁾ These characteristics also relate to basic requirement for construction works 4. ²⁾ Load bearing capacity and stiffness regarding mechanical actions perpendicular to and in plane of the solid wood slab element.		

3.1.1 Hygiene, health and the environment

The release of dangerous substances is determined according to EAD 130005-00-0304, “Solid wood slab element to be used as a structural element in buildings”. No dangerous substances is the performance of CLT – Cross Laminated Timber in this respect.

NOTE In addition to the specific clauses relating to dangerous substances contained in the European Technical Assessment, there may be other requirements applicable to the products falling within its scope (e.g. transposed European legislation and national laws, regulations and administrative provisions). In order to meet the provisions of the Construction Products Regulation, these requirements need also to be complied with, when and where they apply.

3.2 Assessment methods

3.2.1 General

The assessment of the essential characteristics in Clause 3.1 of CLT – Cross Laminated Timber for the intended use, and in relation to the requirements for mechanical resistance and stability, for safety in case of fire, for hygiene, health and the environment, for safety and accessibility in use, for protection against noise and for energy economy and heat retention in use in the sense of the basic requirements for construction works № 1 to 6 of Regulation (EU) № 305/2011 has been made in accordance with the European Assessment Document EAD 130005-00-0304, Solid wood slab element to be used as a structural element in buildings.

3.2.2 Identification

The European Technical Assessment for CLT – Cross Laminated Timber is issued on the basis of agreed data that identify the assessed product. Changes to materials, to composition, to characteristics of the product, or to the production process could result in these deposited data being incorrect. Österreichisches Institut für Bautechnik should be notified before the changes are implemented, as an amendment of the European Technical Assessment is possibly necessary.

4 Assessment and verification of constancy of performance (thereafter AVCP) system applied, with reference to its legal base

4.1 System of assessment and verification of constancy of performance

According to Commission Decision 97/176/EC the system of assessment and verification of constancy of performance to be applied to CLT – Cross Laminated Timber is System 1. System 1 is detailed in Commission Delegated Regulation (EU) № 568/2014 of 18 February 2014, Annex, 1.2., and provides for the following items

- (a) The manufacturer shall carry out
 - (i) factory production control;
 - (ii) further testing of samples taken at the manufacturing plant by the manufacturer in accordance with a prescribed test plan⁵;
- (b) The notified product certification body shall decide on the issuing, restriction, suspension or withdrawal of the certificate of constancy of performance of the construction product on the basis of the outcome of the following assessments and verifications carried out by that body:
 - (i) an assessment of the performance of the construction product carried out on the basis of testing (including sampling), calculation, tabulated values or descriptive documentation of the product;

⁵ The prescribed test plan has been deposited with Österreichisches Institut für Bautechnik and is handed over only to the notified product certification body involved in the procedure for the assessment and verification of constancy of performance. The prescribed test plan is also referred to as control plan.

- (ii) initial inspection of the manufacturing plant and of factory production control;
- (iii) continuous surveillance, assessment and evaluation of factory production control.

4.2 AVCP for construction products for which a European Technical Assessment has been issued

Notified bodies undertaking tasks under System 1 shall consider the European Technical Assessment issued for the construction product in question as the assessment of the performance of that product. Notified bodies shall therefore not undertake the tasks referred to in point 4.1 (b)(i).

5 Technical details necessary for the implementation of the AVCP system, as provided for in the applicable European Assessment Document

5.1 Tasks for the manufacturer

5.1.1 Factory production control

In the manufacturing plant the manufacturer shall establish and continuously maintain a factory production control. All procedures and specification adopted by the manufacturer shall be documented in a systematic manner. The factory production control shall ensure the constancy of performances of CLT – Cross Laminated Timber with regard to the essential characteristics.

The manufacturer shall only use raw materials supplied with the relevant inspection documents as laid down in the control plan. The incoming raw materials shall be subject to controls by the manufacturer before acceptance. Check of incoming materials shall include control of inspection documents presented by the manufacturer of the raw materials.

The frequencies of controls conducted during manufacturing and on the assembled product are defined by taking account of the manufacturing process of the product and are laid down in the control plan.

The results of factory production control are recorded and evaluated. The records include at least the following data:

- Designation of the product, basic materials and components
- Type of control or test
- Date of manufacture of the product and date of testing of the product or basic materials or components
- Results of controls and tests and, if appropriate, comparison with requirements
- Name and signature of person responsible for factory production control

The records shall be kept at least for ten years time after the construction product has been placed on the market and shall be presented to the notified product certification body involved in continuous surveillance. On request they shall be presented to Österreichisches Institut für Bautechnik.

5.1.2 Declaration of performance

The manufacturer is responsible for preparing the declaration of performance. When all the criteria of the assessment and verification of constancy of performance are met, including the certificate of conformity issued by the notified product certification body, the manufacturer shall draw up a declaration of performance.

Figure 4: Pattern of lamellae type “REX” to be used as transverse layers

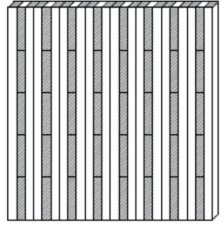
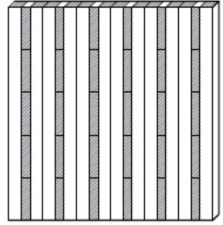
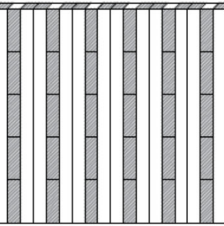
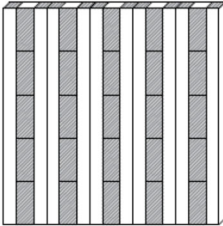
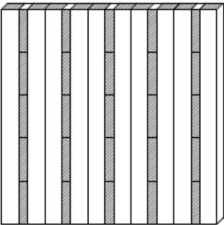
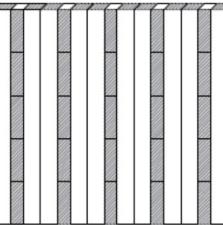
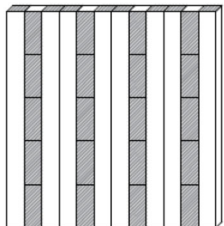
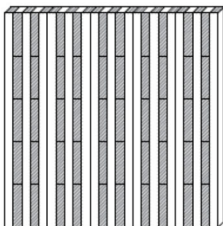
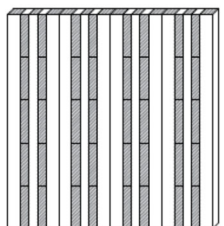
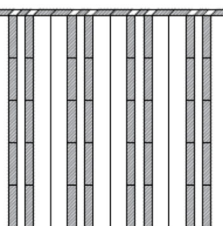
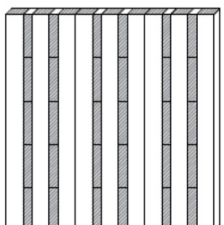
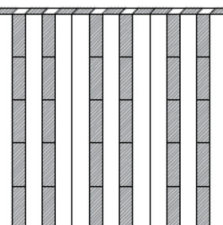
Type	Illustration	Lamellae type “REX”	Type	Illustration	Lamellae type “REX”
REX 60L3s		20-20-20 33 % end grain in the face	REX 80 L3s		30-20-30 25 % end grain in the face
REX 90 L3s		30-30-30 33 % end grain in the face	REX 100 L3s		30-40-30 40 % end grain in the face
REX 100 L3s-B		40-20-40 20 % end grain in the face	REX 110 L3s		40-30-40 27 % end grain in the face
REX 120 L3s		40-40-40 33 % end grain in the face	REX 100 L5s		20-20-20-20-20 40 % end grain in the face
REX 120 L5s		30-20-20-20-30 33 % end grain in the face	REX 140 L5s		40-20-20-20-40 29 % end grain in the face
REX 160 L5s		40-20-40-20-40 25 % end grain in the face	REX 180 L5s		40-30-40-30-40 33 % end grain in the face

CLT – Cross Laminated Timber

Annex 2

Structure of cross laminated timber

of European Technical Assessment
ETA-14/0349 of 15.12.2022

Table 3: Product characteristics of the solid wood slab

BWR	Essential characteristic	Assessment method	Level / Class / Description
1	Mechanical resistance and stability		
	1. Mechanical actions perpendicular to cross laminated timber ¹⁾		
	Strength class of boards	EN 338	See Table 2
	Modulus of elasticity		
	– parallel to the grain of the boards $E_{0, mean}$	EAD 130005-00-0304, 2.2.1.1, I_{eff}	C16/T11 8 000 MPa C24/T14 12 000 MPa ²⁾ C30/T21 12 000 MPa
	– perpendicular to the grain of the boards $E_{90, mean}$	EN 338	C16/T11 270 MPa C24/T14 370 MPa C30/T21 400 MPa
	Shear modulus		
	– parallel to the grain of the boards $G_{090, mean}$	EN 338	C16/T11 500 MPa C24/T14 690 MPa C30/T21 750 MPa
	– perpendicular to the grain of the boards (rolling shear) $G_{9090, mean}$	EAD 130005-00-0304, 2.2.1.1	50 MPa
	Bending strength		
– parallel to the grain of the boards $f_{m, k}$	EAD 130005-00-0304, 2.2.1.1, W_{eff}	C16/T11 $1/k_{sys} \cdot 17.6 \text{ MPa}^3)$ C24/T14 $1/k_{sys} \cdot 26.4 \text{ MPa}^3)$ C30/T21 $1/k_{sys} \cdot 33.0 \text{ MPa}^3)$	
Tensile strength			
– perpendicular to the grain of the boards $f_{t, 90, k}$	EN 338, reduced	0.12 MPa	
Compressive strength			
– perpendicular to the grain of the boards $f_{c, 90, k}$	EN 338	C16/T11 2.2 MPa C24/T14 2.5 MPa C30/T21 2.7 MPa	

NOTE ¹⁾ CLT – Cross Laminated Timber with transverse layers of lamellae type “REX” may be considered equivalent to C24/T14

²⁾ $E_{0, mean} = 6\,800 \text{ MPa}$ for lamellae type “REX”

³⁾ $k_{sys} = \max\{1.0; 1.1 - 0.025 \cdot n\}$ n ... number of boards within cover layer

CLT – Cross Laminated Timber

Annex 3

Characteristic data of cross laminated timber

of European Technical Assessment
ETA-14/0349 of 15.12.2022

BWR	Essential characteristic	Assessment method	Level / Class / Description
	2. Mechanical actions in plane of cross laminated timber ¹⁾		
	Strength class of boards	EN 338	See Table 2
	Modulus of elasticity – parallel to the grain of the boards $E_{0, mean}$	EAD 130005-00-0304, 2.2.1.1, A_{net} , I_{net}	C16/T11 8 000 MPa C24/T14 12 000 MPa ²⁾ C30/T21 12 000 MPa
	Shear modulus – parallel to the grain of the boards $G_{090, mean}$	EAD 130005-00-0304, 2.2.1.3, A_{net}	460 MPa
	Bending strength – parallel to the grain of the boards $f_{m, k}$	EAD 130005-00-0304, 2.2.1.1, W_{net}	C16/T11 16 MPa C24/T14 24 MPa C30/T21 30 MPa
	Tensile strength – parallel to the grain of the boards $f_{t, 0, k}$	EN 338	C16/T11 8.5 MPa C24/T14 14.5 MPa C30/T21 19.0 MPa
	Compressive strength – parallel to the grain of the boards $f_{c, 0, k}$	EN 338	C16/T11 17 MPa C24/T14 21 MPa C30/T21 24 MPa
	Shear strength – parallel to the grain of the boards $f_{v, 090, k}$	EAD 130005-00-0304, 2.2.1.3, A_{net} ³⁾	3.9 MPa ⁵⁾
NOTE	⁵⁾ $A_{net} = \max \begin{cases} A_{net,x} \\ A_{net,z} \end{cases}$		
CLT – Cross Laminated Timber		Annex 3	
Characteristic data of cross laminated timber		of European Technical Assessment ETA-14/0349 of 15.12.2022	

electronic copy electronic copy electronic copy electronic copy electronic copy electronic copy electronic copy electronic copy electronic copy electronic copy

BWR	Essential characteristic	Assessment method	Level / Class / Description	
	3. Other mechanical actions			
	Creep and duration of load	EN 1995-1-1		
	Dimensional stability Moisture content during service shall not change to such an extent that adverse deformation will occur.			
	Fasteners	EN 1995-1-1, the direction of grain of the cover layer shall be taken as reference		
	In-service environment			
	Durability of timber	EN 1995-1-1		
	Service classes		1 and 2	
	Bond integrity	EAD 130005-00-0304	Pass	
2	Safety in case of fire			
	<u>Reaction to fire</u>			
	Glued laminated timber products	Commission Decision 2005/610/EC	Mean density of wood $\geq 380 \text{ kg/m}^3$ Euroclass D-s2, d0	
	<u>Resistance to fire</u>			
	Structures with specified fire resistance	EN 13501-2	Annex 4	
	Charring rate		Floor/Roof	Wall
	- Charring of the cover layer - Charring of more layers than the cover layer	EAD 130005-00-0304	0.65 mm/min 1.3 mm/min ⁶⁾	0.63 mm/min 0.86 mm/min
3	Hygiene, health and environment			
	Vapour permeability, μ , for wood	EN ISO 10456	50 (dry) to 20 (wet)	
4	Safety and accessibility in use			
	Impact resistance	Soft body resistance is assumed to be fulfilled for walls with a minimum of 3 layers and minimum thickness of 60 mm.		
CLT – Cross Laminated Timber		Annex 3		
Characteristic data of cross laminated timber		of European Technical Assessment ETA-14/0349 of 15.12.2022		

NOTE ⁶⁾ until 25 mm of charring. Afterwards the charring rate 0.65 mm/min applies up to the next glue line

electronic copy electronic copy electronic copy electronic copy electronic copy electronic copy electronic copy electronic copy electronic copy electronic copy

BWR	Essential characteristic	Assessment method	Level / Class / Description
5	Protection against noise		
	Airborne sound insulation	EN ISO 10140-2, EN ISO 717-1	For R_w (C ; C_{tr}), see Annex 5
	Impact sound insulation	EN ISO 10140-3, EN ISO 717-2	For $L_{n,w}$ (C_i) see Annex 5
	Sound absorption	EN ISO 354, EN ISO 11654	For α_s see Annex 5
6	Energy economy and heat retention		
	Thermal conductivity, λ , of wood	EN ISO 10456	0.12 W/(m·K)
	Air permeability	EN 12114	Class 4 according to EN 12207
	Thermal inertia, specific heat capacity, c_p , of wood	EN ISO 10456	1600 J/(kg·K)
CLT – Cross Laminated Timber		Annex 3	
Characteristic data of cross laminated timber		of European Technical Assessment ETA-14/0349 of 15.12.2022	

Cladding on the fire exposed side	Mounting	CLT element	Test load	Tested wall height	Classification
		Designation and structure [mm]	[kN/m]	[m]	i => o
2 x 15 mm gypsum plasterboard type DF according to EN 520, $\rho \geq 800 \text{ kg/m}^3$	First layer: ribbed nails $l = 40 \text{ mm}$ Second layer: ribbed nails $l = 40 \text{ mm}$ (left side) and staples $l = 45 \text{ mm}$ (right side) with $a = 75/150 \text{ mm}$ (edge/centre) row distance 625 mm	CLT 80 C3s 30-20-30	–	3	EI 90
12.5 mm gypsum plasterboard type DF according to EN 520, $\rho \geq 800 \text{ kg/m}^3$	Drywall screws 3.9 mm x 35 mm with $a = 75/150 \text{ mm}$ (edge/centre) row distance 625 mm	CLT 100 C3s 30-40-30	35	3	REI 90
12.5 mm gypsum plasterboard type DF according to EN 520, $\rho \geq 800 \text{ kg/m}^3$ 40 mm mineral wool according to EN 13162, $\rho = 11 \text{ kg/m}^3$	Drywall screws 3.9 mm x 35 mm with $a = 75/150 \text{ mm}$ (edge/centre) row distance 625 mm	CLT 100 C3s 30-40-30	35	3	REI 90
50 mm wood wool board Heraklioth BM type L1/L2-W1-T1-S1/S2-P1-CS(10/Y)150-CI3 according to EN 13168, $\rho = 18.5 \text{ kg/m}^3$ 15 mm plaster	Heraklioth screws 5 mm x 80 mm with $a = 150 \text{ mm}$ row distance 625 mm	CLT 100 C3s 30-40-30 CLT 100 C5s 20-20-20-20-20	35	3	REI 90
Hat- spring bar Protektor 60-27 according to EN 14195 40 mm glass wool Ursa Trennwandfilz TWF 1 according to EN 13162 12.5 mm fermacell Gypsum Fibreboard with fibrous reinforcement type GF-I-W2-C1 according to ETA-03/0050, $\rho = 1\,150 \pm 50 \text{ kg/m}^3$	Wood screws with flat head 4.2 mm x 35 mm with $a = 600 \text{ mm}$ Drywall screws 3.9 mm x 30 mm with $a = 250 \text{ mm}$	CLT 120 C3s 40-40-40	120	3	REI 90
12.5 mm fermacell Gypsum Fibreboard with fibrous reinforcement type GF-I-W2-C1 according to ETA-03/0050, $\rho = 1\,150 \pm 50 \text{ kg/m}^3$	Staples with $a = 150 \text{ mm}$, row distance 400 mm	CLT 120 C3s 40-40-40	120	3	REI 90
2 x 15 mm fermacell Gypsum Fibreboard with fibrous reinforcement type GF-I-W2-C1 according to ETA-03/0050, $\rho = 1\,150 \pm 50 \text{ kg/m}^3$	First layer: staples with $a = 200 \text{ mm}$, row distance 625 mm Second layer: staples with $a = 150 \text{ mm}$, row distance 400 mm	CLT 120 C3s 40-40-40	200	3	REI 90
CLT – Cross Laminated Timber		Annex 4			
Resistance to fire		of European Technical Assessment ETA-14/0349 of 15.12.2022			

Cladding on the fire exposed side	Mounting	CLT element	Test load	Tested wall height	Classification
		Designation and structure [mm]	[kN/m]	[m]	i => o
2 x 18 mm gypsum plasterboard type DF according to EN 520, $\rho \geq 800 \text{ kg/m}^3$	First layer: staples with $a = 200 \text{ mm}$, row distance 625 mm Second layer: staples with $a = 80 \text{ mm}$, row distance 625 mm	CLT 80 C3s 20-40-20	100	3.28	REI-M 90
15 mm and 18 mm fermacell Gypsum Fibreboard with fibrous reinforcement type GF-I-W2-C1 according to ETA-03/0050, $\rho = 1\,150 \pm 50 \text{ kg/m}^3$	First layer: staples with $a \leq 200 \text{ mm}$, row distance 625 mm Second layer: staples with $a \leq 150 \text{ mm}$, row distance 400 mm	CLT 80 C3s 20-40-20	120	3	REI-M 90
12.5 mm gypsum plasterboard type DF according to EN 520, $\rho \geq 800 \text{ kg/m}^3$	Drywall screws 3.5 mm x 35 mm with $a = 250 \text{ mm}$ row distance 400 mm	CLT 100 C3s 30-40-30	50	3	REI 90
CLT – Cross Laminated Timber		Annex 4			
Resistance to fire		of European Technical Assessment ETA-14/0349 of 15.12.2022			

electronic copy electronic copy electronic copy electronic copy electronic copy electronic copy electronic copy

Performances E and I – integrity and insulation

The criteria E (integrity) and I (insulation) as well as the smoke tightness at an undisturbed element in terms of fire protection and the surface temperature at the unexposed fire side are considered to be fulfilled if

- the distance between the non-charred bond line and the 300°C isotherm is ≥ 15 mm and
- the residual timber cross-section consists of at least one non-charred bond line and a layer above it.

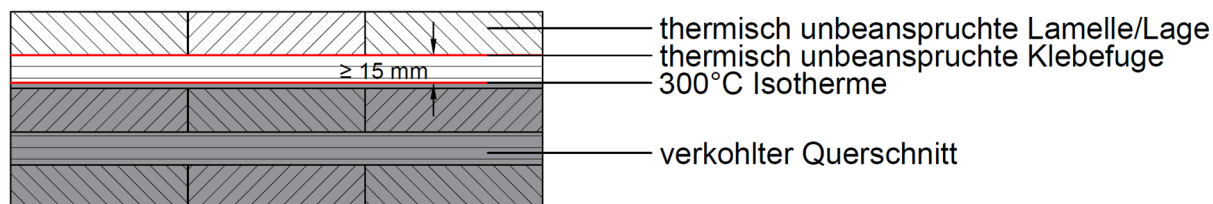

The design of element joints, e.g. with stepped rebate or top-side cover board, fulfil the criteria E (integrity) and I (insulation) if a residual timber cross-section of 2 cm exists up to the element joint, e.g. stepped rebate or cover board.

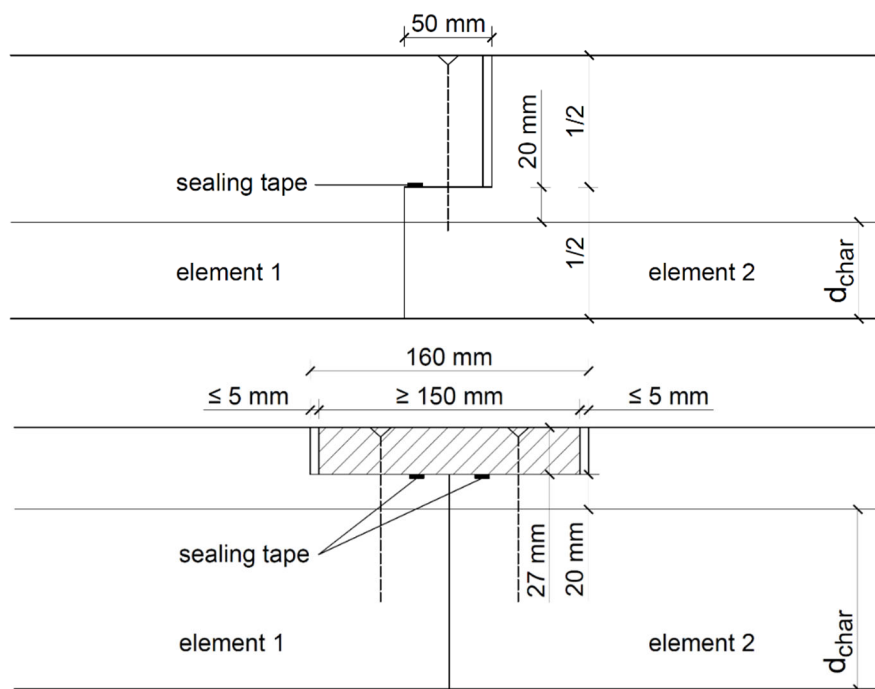



Sealing tapes are not required for the above-mentioned joints if

- the surface temperature is $< 120^{\circ}\text{C}$ and
- the maximum distance of the screw connection of 250 mm is observed.
- For stepped rebate joints, the temperature in the rebate area must be $< 150^{\circ}\text{C}$ and the maximum distance of the screw connection must be < 250 mm.

CLT – Cross Laminated Timber	Annex 4
Resistance to fire	of European Technical Assessment ETA-14/0349 of 15.12.2022

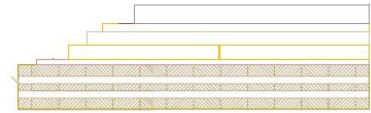
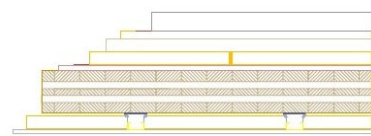
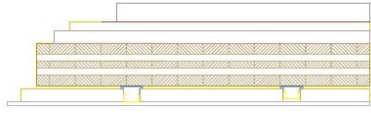
Examples for airborne and impact sound insulation

No	Floor elements		
F 1	140 mm	CLT 140 NVI L5S, 428 kg/m ³	L_{n,w}(C_i) = 88 (-5) dB 
F 2	70 mm 0.2 mm 30 mm 50 mm 50 mm 0.2 mm 18 mm 140 mm	Cement screed, 2210 kg/m ³ Vapour barrier sheet Impact sound insulation board, 72 kg/m ³ , s' = 10 MN/m ³ Ballast weight, 1650 kg/m ³ Paving slab, 2320 kg/m ³ Trickle course Soft fibre board, 250 kg/m ³ CLT 140 NVI L5S, 428 kg/m ³	L_{n,w}(C_i) = 41 (1) dB 
F 3	70 mm 0.2 mm 30 mm 50 mm 50 mm 0.2 mm 18 mm 140 mm 3 mm 70 mm 15 mm	Cement screed, 2210 kg/m ³ Vapour barrier sheet Impact sound insulation board, 72 kg/m ³ , s' = 10 MN/m ³ Ballast weight, 1650 kg/m ³ Paving slab, 2320 kg/m ³ Trickle protection Soft fibre board, 250 kg/m ³ CLT 140 NVI L5S, 428 kg/m ³ Connection sealing tape Acoustical mounting including 50 mm thermal insulation, 16 kg/m ³ Gypsum plasterboard, 800 kg/m ³	L_{n,w}(C_i) = 36 (3) dB 
F 4	70 mm 0.2 mm 30 mm 50 mm 140 mm 3 mm 70 mm 15 mm	Cement screed, 2210 kg/m ³ Vapour barrier sheet Impact sound insulation board, 72 kg/m ³ , s' = 10 MN/m ³ Ballast weight, 1650 kg/m ³ CLT 140 NVI L5S, 428 kg/m ³ Connection sealing tape Acoustical mounting including 50 mm thermal insulation, 16 kg/m ³ Gypsum plasterboard, 800 kg/m ³	L_{n,w}(C_i) = 46 (1) dB 
F 5	70 mm 0.2 mm 30 mm 50 mm 140 mm	Cement screed, 2210 kg/m ³ Vapour barrier sheet Impact sound insulation board, 72 kg/m ³ , s' = 10 MN/m ³ Ballast weight, 1650 kg/m ³ CLT 140 NVI L5S, 428 kg/m ³	L_{n,w}(C_i) = 50 (-1) dB 
F 6	70 mm 0.2 mm 30 mm 50 mm 20 mm 140 mm	Cement screed, 2210 kg/m ³ Vapour barrier sheet Impact sound insulation board, 72 kg/m ³ , s' = 10 MN/m ³ Ballast weight, 1650 kg/m ³ Impact sound insulation board, 69 kg/m ³ , s' = 14 MN/m ³ CLT 140 NVI L5S, 428 kg/m ³	L_{n,w}(C_i) = 49 (1) dB 

CLT – Cross Laminated Timber

Protection against noise

Annex 5

of European Technical Assessment
ETA-14/0349 of 15.12.2022

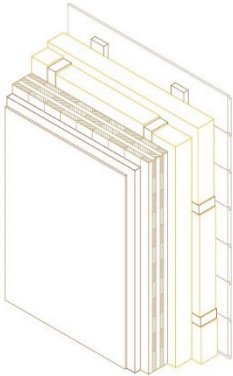
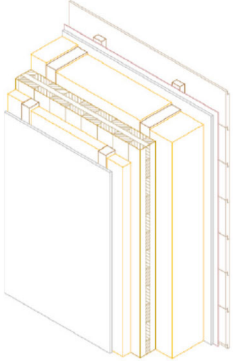
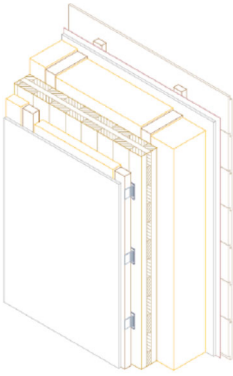
electronic copy	W 12	20 mm 27 mm 0.4 mm 100 mm 100 mm 120 mm 35 mm 10 mm	Rabbit edge shuttering of larch, 536 kg/m ³ Spread shuttering, 640 kg/m ³ Shuttering layer Wooden battens, 542 kg/m ³ including 100 mm façade insulation board, 25 kg/m ³ , cross layer Wooden battens, 542 kg/m ³ including 100 mm façade insulation board, 25 kg/m ³ CLT 120 NVI C5S, 445 kg/m ³ Clay building board, 1043 kg/m ³ Clay rendering including glass fibre reinforcement	R_w(C; C_{tr}) = 54 (-2; -7) dB 
	W 13	20 mm 30 mm 0.3 mm 15 mm 200 mm 100 mm 94 mm 60 mm 12.5 mm	Shuttering, laterally closed*/open all around** Timber beams 30/50 Foil (diffusion open) Gypsum fibre board, 1190 kg/m ³ Wooden battens 200/60, e = 62.5 cm including 200 mm thermal hemp-mats, 30 kg/m ³ CLT 3s or 5s Wooden battens 60/60, e = 62.5 cm including 50 mm mineral wool, 13 kg/m ³ Gypsum plasterboard, 810 kg/m ³	R_w(C; C_{tr}) = 46 (-2; -5) dB * R_w(C; C_{tr}) = 45 (-1; -4) dB ** 
	W 14	20 mm 30 mm 0.3 mm 15 mm 200 mm 100 mm 94 mm 70 mm 12.5 mm	Shuttering Timber beams 30/50 Foil (diffusion open) Gypsum fibre board, 1190 kg/m ³ Wooden battens 200/60, e = 62.5 cm including 200 mm thermal hemp-mats*, 30 kg/m ³ or wood fibre insulation board**, 58kg/m ³ CLT 3s or 5s Acoustical mounting including 50 mm mineral wool, 13 kg/m ³ Gypsum plasterboard, 810 kg/m ³	R_w(C; C_{tr}) = 51 (-2; -7) dB * R_w(C; C_{tr}) = 53 (-2; -8) dB ** 
CLT – Cross Laminated Timber	Annex 5			
Protection against noise	of European Technical Assessment ETA-14/0349 of 15.12.2022			

EAD 130005-00-0304, European Assessment Document for “Solid wood slab element to be used as a structural element in buildings”

ETA-03/0050, European Technical Assessment ETA-03/0050 of 25 March 2022 for „fermacell Gypsum fibre boards – fermacell Gipsfaserplatte, fermacell Vapor, fermacell Gipsfaser-Platte greenline“ from James Hardie Europe GmbH, Bennigsen Platz 1, 40474 Düsseldorf, Germany

EN 301 (11.2017), Adhesives, phenolic and aminoplastic, for load-bearing timber structures – Classification and performance requirements

EN 338 (04.2016), Structural timber – Strength classes

EN 520:2004+A1 (08.2009), Gypsum plasterboards – Definitions, requirements and test methods

EN 1995-1-1 (11.2004), +AC (06.2006), +A1 (06.2008), +A2 (05.2014), Eurocode 5 – Design of timber structures - Part 1-1: General – Common rules and rules for buildings

EN 1995-1-2 (11.2004) +AC (06.2006), +AC (03.2009), Eurocode 5 – Design of timber structures – Part 1-2: General – Structural fire design

EN 12114 (03.2000), Thermal performance of buildings – Air permeability of building components and building elements – Laboratory test method

EN 13162:2012+A1 (02.2015), Thermal insulation products for buildings – Factory made mineral wool (MW) products – Specification

EN 13168:2012+A1 (02.2015), Thermal insulation products for buildings – Factory made wood wool (WW) products – Specification

EN 13183-2 (04.2002), Moisture content of a piece of sawn timber – Part 2: Estimation by electrical resistance method

EN 13501-2 (06.2016), Fire classification of construction products and building elements – Part 2: Classification using data from fire resistance tests, excluding ventilation services

EN 13986:2004+A1 (04.2015), Wood-based panels for use in construction – Characteristics, evaluation of conformity and marking

EN 14080 (06.2013), Timber structures – Glued laminated timber and glued solid timber – Requirements

EN 14195 (12.2014), Metal framing components for gypsum board systems – Definitions, requirements and test methods

EN 15283-2:2008+A1 (08.2009), Gypsum boards with fibrous reinforcement – Definitions, requirements and test methods – Part 2: Gypsum fibre boards

CLT – Cross Laminated Timber	Annex 6
Reference documents	of European Technical Assessment ETA-14/0349 of 15.12.2022

